

\*\*\*\*(NOTE)\*\*\*\*

Standard Dealer discounts do not apply on  
two stage snowblowers  
Call for info

## Reist Industries Inc SnowBlowers

two stage  
(CND) LIST

**8000 Series (Triple Auger) PTO Driven Snowblower** (Base Unit does not include chute or options)

Description	Part #
108" Two Stage, 1000rpm, 150-300 hp, 50" fan, 24" Solid Flight Bottom Auger, 14" Middle & Top CAT II Hitch, Rotating Fan Housing, Left and Right Side Discharge	8108
120" Two Stage, 1000rpm, 150-300 hp, 50" fan, 24" Solid Flight Bottom Auger, 14" Middle & Top CAT II Hitch, Rotating Fan Housing, Left and Right Side Discharge	8120

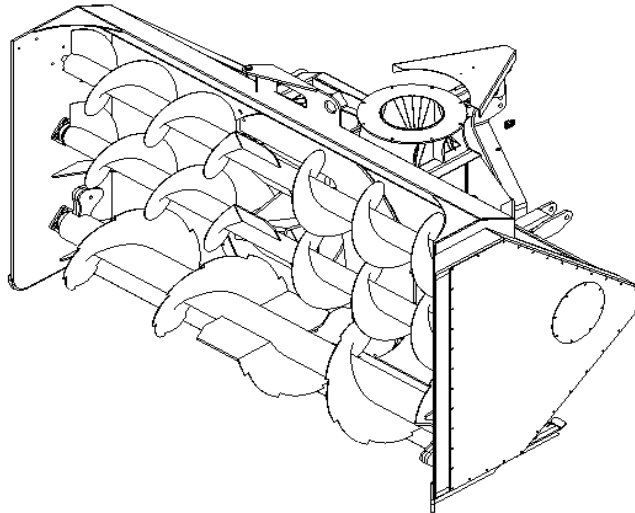

\*\*\*\*(NOTE)\*\*\*\*

Standard Dealer discounts do not apply on  
two stage snowblowers  
Call for info

Reist Industries Inc  
SnowBlowers  
two stage  
(CND) LIST

**8000 SERIES OPTIONS**

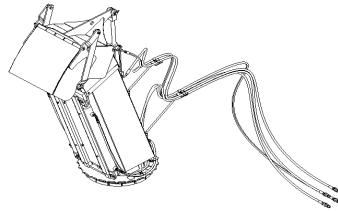
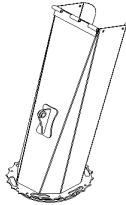
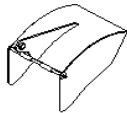
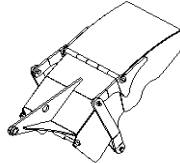
Telescopic truck loading chute with two stage deflector (price includes deflector, cyl. & hoses)		<b>Part #</b>
	TCTSHD	
Straight Chute (price does not include deflector, cyl. & hoses)		SC
	Single Stage Hood Deflector	
Two Stage Hood Deflector		
	Hood Deflector Cylinder (2x8) & Hoses	HD-H-KIT

\*\*\*\*(NOTE)\*\*\*\*

Standard Dealer discounts do not apply on  
two stage snowblowers  
Call for info

## Reist Industries Inc SnowBlowers

two stage  
(CND) LIST

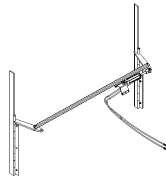
Bank Cutters (bolt on)		BC-8000
Steering Bank Cutters (Includes cyl. & hoses)		SBC-8000

### **FRONT MOUNTING KIT for tractors without Front PTO & 3PH**

Description	Part#
Push Frame with Drive Shaft	SB-FMK
Hydraulic Lift Kit with cylinder & hoses	SB-HLK
Rear Transfer Case	SB-RTC
PTO Kits for rear Transfer Case	SB-UJK